

Data Sheet



Article number: 03503035

Description: Fluro Rod end GE 35HO-2RS

Measures

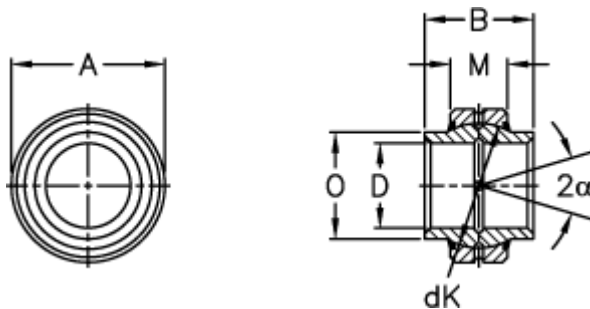

A	= 55 0 -0,013	Tilt angle = 3
B	= 35	Weight = 260
D	= 35 0 -0,012	
dK	= 47	
Dynamic load C (kN)	= 80	
M	= 20	
O	= 40	
Static load C0 (kN)	= 400	